

MEYER OFF-ROAD VEHICLE PRODUCT GUIDE | 2015



Meyer[®]
REINVENTED EVERY DAY.



Table of Contents

Introduction..... 1

Off-Road Vehicle
Product Line..... 2-3



Plows for ATVs, Light-Duty
UTVs and ZTRs..... 4-6



Plows for Heavy-Duty UTVs, Compact
Tractors and Airport Tractors..... 7-9



Plows for Compact/Utility Tractors
and Skid Steers..... 10-13



Plows for Compact/Utility Tractors
and Skid Steers..... 10-13

Plow Accessories..... 14-16

Accessories
Reference Guide..... 17-20



Off-Road Vehicle Spreaders..... 21

Add a Meyer® Plow for Year-Round Productivity.





Meyer Products has been the leading brand in commercial snow and ice control products since 1926. During that time we have helped people in North America and in countries around the world battle some of nature's toughest storms. Over the years this experience has allowed us to expand and develop products that are perfect for specialty application vehicles such as ATVs, UTVs, tractors and skid steer vehicles. As this segment evolves, Meyer has kept pace, developing innovative plows and spreaders allowing these vehicles to be used all four seasons.



Meyer fits the biggest names in the off-road business.



MEYER OFF-ROAD VEHICLE PLOW PRODUCT LINE

Your Off-Road Vehicle Plow Source

Meyer is your one source for all off-road vehicle plows. Being a leader in the industry for over 87 years allows us to offer the widest variety of plows in the industry that can fit virtually any application. Our plows exceed industry standards so they are guaranteed to perform better and last longer than non-commercial plows. You'll see our quality in the details. It's the only way we know how to build plows – strong, reliable and easy-to-use.



Designed to fit into tight areas where large vehicles can't reach. They feature flared wings, inspired by highway plows, to help remove snow faster than any other plow on the market. Available in 50," 60" and 72" lengths.



Compact, contractor-grade plow for smaller vehicles. Receiver hitch version available with full hydraulics or self-angle to help maximize snow removal efficiency. Available in 5', 6', 6'8" and 7'6" (full hydraulic only) lengths.



Contractor-grade, full-trip plow featuring the tallest moldboard in its class for fast snow removal. Adding optional multi-position wings allows the plow to adjust to a straight, scoop or box plow configuration. Lot Pro plows are available in 7'6" to 10' lengths.



Contractor-grade plow featuring a trip-edge that allows the moldboard to remain upright and performing, while the lower portion gives way when major obstacles are struck. Available in 7'6" to 9' lengths.



Mounting Methods by Plow and Vehicle Type

Mounts for Path Pro Series

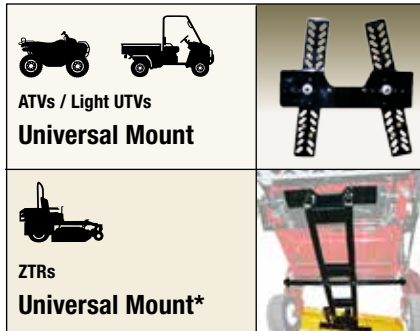

* Custom mount in addition to universal mount may be required for certain vehicles.

Mounts for Drive Pro Series

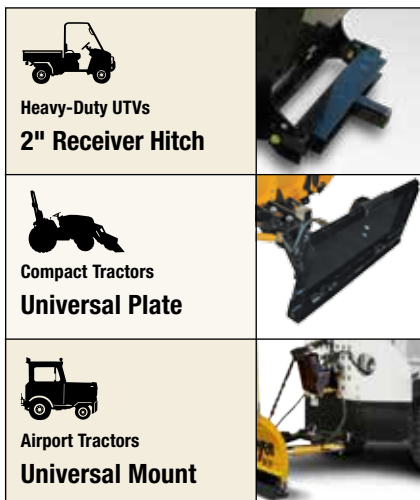

Mounts for Lot Pro and Diamond Edge Plows

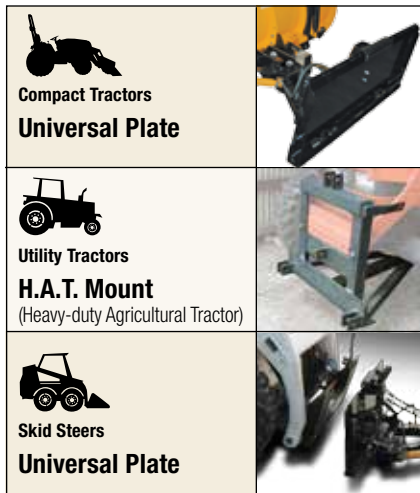

How to Choose the Right Size Plow

Meyer recommends installing a plow wider than the outside edge of the vehicle's track when the plow is at full angle. Meyer offers a variety of plow widths allowing you to order the correct size plow for your vehicle and application.



When selecting a plow for ATVs, Light-duty UTVs and ZTRs

Track Width	Recommended Plow Models
30" - 44"	Path Pro (PP-50")
45" - 53"	Path Pro (PP-60")
54" - 62"	Path Pro (PP-72")

When selecting a plow for Heavy-duty UTVs

Track Width	Recommended Plow Models
48"	Drive Pro (DP 5.0)
48"- 60"	Drive Pro (DP 6.0)
60" and up	Drive Pro (DP 6.8)

When selecting a plow for a Compact Tractor or Skid Steer

Track Width	Horse Power	Recommended Plow Models
up to 48"	20-30 HP	DP 6'0", DP 6'8"
	30-45 HP	DP 6'8", DP 7'6"
	45-75 HP	LP 7'6", LP 8'0"
	75 HP and over	LP 8'0", LP 9'0", LP 10'0"
49" to 66"	20-30 HP	DP 6'8"
	30-45 HP	DP 7'6"
	45-75 HP	LP 7'6", LP 8'0"
67" and up*	75 HP and over	LP 8'0", LP 9'0", LP 10'0"
	20-30 HP	Not Recommended
	30-45 HP	DP 7'6", LP 7'6"
	45-75 HP	LP 7'6", LP 8'0"

*End user needs to verify that blade covers track width at full angle.

PLOWS FOR ATVs, LIGHT-DUTY UTVs AND ZTRs



The perfect plow for these vehicles:



ATVs



Light-Duty UTVs



ZTR Mowers



The Path Pro is perfect for clearing snow in tight areas where other plows can't go.

Now you can have a commercial grade plow for smaller off-road vehicles. Path Pro plows are built to take the punishment less expensive brands can't handle. For performance and reliability there is nothing like it on the market.

Raising/lowering the blade.

ATVs / UTVs Vehicles

Optional Manual Lift Kit

Can be used on ATVs or UTVs only. Kit raises and lowers the plow when a power winch is not available. Reversible handle can be installed on the right- or left-hand side. (Part #13860)



Power Winch

Attaching a power winch to the Path Pro frame allows you to raise and lower the blade. Power winches are standard equipment on many vehicles.



ZTRs

ZTR Foot Pedal

Path Pros utilize the existing ZTR decklift foot pedals to raise and lower the blade.



See page 21 for spreaders that fit ATVs.

Path Pro's unique highway plow design clears snow faster from sidewalks and tight areas.

The Meyer Path Pro is a commercial-grade, full-trip plow available in 50", 60" or 72" widths. Path Pro's 65-degree attack angle scrapes the surface more cleanly than standard non-commercial straight blades. Shop around and you will find there's nothing like it on the market.

Commercial grade plow design.

DURA-SLICK™
Paint System Automotive style paint with Teflon® for durability and better snow-rolling action

Reversible cutting edge extends usable life

Highway style pivot bar and push frame

Easily accessible grease points at high-wear areas



Scoop & Funnel™ highway plow inspired design.

The highway-plow inspired flared wings scoop and funnel the snow faster and throws it farther than competitive blades.

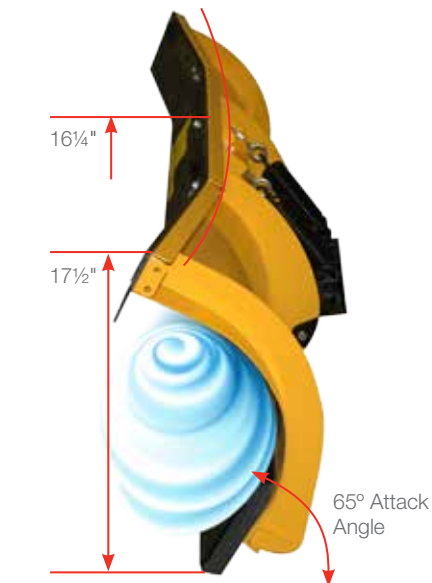

Patented Self-Angling or Lock-n-Go... Both standard on the Path Pro.

SELF-ANGLING



Only the Path Pro comes with automatic self-angling. Self-angling senses which side of the plow is gathering the most snow, then automatically angles the blade in that direction. Perfect if you don't want to leave the vehicle or...



If you prefer, you can lock the plow in one of five different positions, left or right, using the Lock-n-Go system.

LOCK-N-GO SYSTEM



Universal Mounting System...for any kind of ATV, UTV or ZTR.

The Path Pro comes with brackets to easily and securely attach it to just about any ATV, light-duty UTV or ZTR. The brackets are designed to provide maximum ground clearance once the plow is attached.

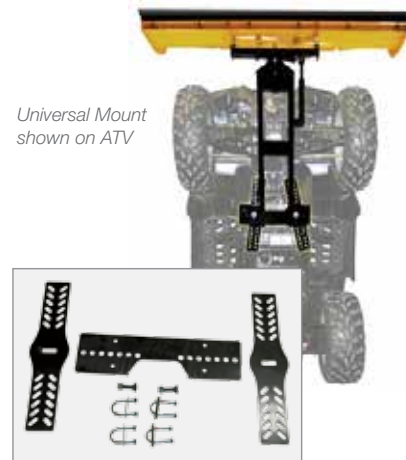

TO ORDER, USE THE COMPLETE KIT NUMBER.

***COMPLETE KITS INCLUDE > Moldboard > Pivot Bar > Push Frame > Universal Mount > Hardware**



ATV PLOW ORDER INFORMATION AND SPECIFICATIONS

Complete Kit* #	Plow Model #	Mounting Type	Blade Type	Moldboard Length	Moldboard Height	Moldboard Gauge	Vertical Ribs	Plow Trip Springs	Steel Cutting Edge	Average Width at Full Angle	Self Angling Rams	Weight Complete
29000	PP-50	Universal ATV	Path Pro	50"	16.25"-17.5"	14 Steel	4	2	1/4" x 5"	43.3"-47.4"	3/4" x 6-1/4" Spring Loaded	138 lbs.
29100	PP-60	Universal ATV	Path Pro	60"	16.25"-17.5"	14 Steel	4	2	1/4" x 5"	51.9"-56.1"	3/4" x 6-1/4" Spring Loaded	148 lbs.



LIGHT-DUTY UTV PLOW ORDER INFORMATION AND SPECIFICATIONS

Complete Kit† #	Plow Model #	Blade Type	Moldboard Length	Moldboard Height	Moldboard Gauge	Vertical Ribs	Plow Trip Springs	Steel Cutting Edge	Average Width at Full Angle	Self Angling Rams	Weight Complete
29005	PP-50	Path Pro	50"	16.25"-17.5"	14 Steel	4	2	1/4" x 5"	43.3"-47.4"	3/4" x 6-1/4" Spring Loaded	138 lb.
29105	PP-60	Path Pro	60"	16.25"-17.5"	14 Steel	4	2	1/4" x 5"	51.9"-56.1"	3/4" x 6-1/4" Spring Loaded	148 lb.
29205	PP-72	Path Pro	72"	16.25"-17.5"	14 Steel	4	2	1/4" x 5"	62.4"-66.5"	3/4" x 6-1/4" Spring Loaded	170 lb.

† Polaris Razor (2011 and up) requires Part #08913 for mounting the plow to the vehicle. It must be ordered in addition to the Complete Kit.



ZTR PLOW ORDER INFORMATION AND SPECIFICATIONS

Complete Kit* #			ZTR Model	Fits Years	Moldboard Length	Moldboard Height	Moldboard Gauge	Vertical Ribs	Plow Trip Springs	Steel Cutting Edge	Average Width at Full Angle	Self Angling Rams	Weight Complete
50"	60"	72"											
29015	29115	29215	ExMark Lazer Z (X series)	2011 & up	50"	16.25"-17.5"	14 Steel	4	2	1/4" x 5"	43.3"-47.4"	3/4" x 6-1/4" Spring Loaded	138 lb.
29010	29110	29210	Scag Cheeta	2010 & up									
29015	29115	29215	Scag Tiger Cat	2010 & up									
29010	29110	29210	Scag Turf Tiger	2010 & up									
29010	29110	29210	Bob Cat ProCat SE	2011 & up	60"	16.25"-17.5"	14 Steel	4	2	1/4" x 5"	51.9"-56.1"	3/4" x 6-1/4" Spring Loaded	148 lb.
29015** + 08915	29115** + 08915	29215** + 08915	Husqvarna PZ 54	2012 & up									
	29115** + 08916	29215** + 08916	Kubota ZD331	2012 & up									
	29115** + 08917	29215** + 08917	Grass Hopper 430D	2012 & up	72"	16.25"-17.5"	14 Steel	4	2	1/4" x 5"	62.4"-66.5"	3/4" x 6-1/4" Spring Loaded	170 lb.

** Need to order both numbers for Complete Kit.

For available Path Pro accessories, see pages 17-20

Go to www.meyerproducts.com and visit our EZ-Match Tool for current application recommendations.



The perfect plow for these vehicles:



Heavy-Duty UTVs



Compact Tractors



Airport Tractors



▶ Uses a front receiver 2", class 3 hitch for mounting to heavy-duty UTVs.

Meyer® Drive Pro.™ A real snowplow for heavy-duty UTVs, compact tractors and airport tractors.

When you add a Meyer® Drive Pro™ snow plow to your tractor or utility vehicle, you get the perfect solution for plowing sidewalks, long driveways or any space where a pick-up truck isn't appropriate. This contractor-grade plow is available in four moldboard sizes – 5', 6', 6' 8", and 7'6".

Drive Pro full-trip moldboards are designed to give way, absorbing the impact caused by snow covered objects like uneven sidewalks, protecting equipment and ensuring operator safety.



▶ Universal plates are used to mount to compact tractors.

Airport Tractors use universal mounts.



See page 21 for spreaders that fit UTVs and Tractors.

Better performance by design.

The aggressive blade design and taller moldboard removes snow faster and quicker than any other competitive plow.



Lightweight but tough.

Just like our larger contractor plows, Drive Pro plows feature heavy-duty frames, pivot bars and components to take the day-to-day pounding that plowing delivers.



Full-trip moldboard.

The entire moldboard trips when obstacles are encountered during plowing, saving wear and tear on the vehicle and protecting the driver.



Contractor-grade plows for today's hard working vehicles.

With an aggressive attack angle and taller moldboard, Drive Pro plows make quick work of removing snow on sidewalks, driveways or any tight area, making your Compact tractor, Heavy-duty UTV or Airport Tractors more valuable and productive.

DRIVE PRO MOUNT AND MOVEMENT BY VEHICLE TYPE

Vehicle Type	Mount Type	Angling Method	Up/Down Method
Heavy-Duty UTV	Front receiver 2", Class 3	Self angle* or power angle*	Meyer hydraulic*
Compact Tractor	Universal attachment plate*	Central hydraulic	Vehicle loader arms
Airport Tractor	Custom	Power angling rams*	Meyer hydraulic*

* Included in kit

HEAVY-DUTY UTVs REQUIRE A 2" RECEIVER HITCH MOUNT THAT IS VEHICLE SPECIFIC FOR ATTACHING THE PLOW. WHEN ORDERING, USE THE COMPLETE KIT NUMBER AND THE 2" RECEIVER MOUNT NUMBER FOR YOUR SPECIFIC VEHICLE. SEE CHARTS BELOW.



HEAVY-DUTY UTV PLOW ORDER INFORMATION AND SPECIFICATIONS

Complete Kit #	Description	Moldboard Length	Moldboard Height	Average Width at Full Angle	Weight Complete
27500	Self-Angle	5' 0"	22.5"	54"	277 lb.
28500	Power-Angle	5' 0"	22.5"	54"	285 lb.
28530	Power-Angle with Central Hydraulic**	5' 0"	22.5"	54"	285 lb.
27510	Self-Angle	6' 0"	22.5"	65"	301 lb.
28510	Power-Angle	6' 0"	22.5"	65"	301 lb.
28540	Power-Angle with Central Hydraulic**	6' 0"	22.5"	65"	301 lb.
27520	Self-Angle	6' 8"	22.5"	72"	301 lb.
28520	Power-Angle	6' 8"	22.5"	72"	301 lb.
28550	Power-Angle with Central Hydraulic**	6' 8"	22.5"	72"	301 lb.

** Utilizes the vehicles existing central hydraulic system. **NOTE:** Heavy-duty UTVs must be equipped with a front receiver 2", class 3 hitch

HEAVY-DUTY 2" RECEIVER HITCH PLOW VEHICLE MOUNTS FOR HEAVY-DUTY UTVs

Class 3, Front 2" Receiver Hitch Mount*	Manufacturer	Model	Year Range
FHK 45793 6" Extension	Kubota	RTV 500, 900, 1100	2009 & up
09002	Polaris (full sized)	Ranger 800, 4x4 & 6x6	2009 & up
09000	John Deere	HPX	2010 & up
FHK 45058 2" Drop	John Deere	XUV	2010 & up
FHK 45058 2" Drop	John Deere	625i, 825i, 855d	2012 & up
09005	Kawasaki	Mule 4000, 4010	2010 - 2012
09006	Kawasaki	Teryx	2011 & up
09002	Bobcat	3400, 3450	2010 & up
09003	New Holland	Rustler 120, 125	2009 & up
09003	Case	Scout 120	2009 & up
09004	Honda	Big Red	2009 & up

* Class 3 front 2" receiver hitch must be mounted between 10-13" to the centerline of the hitch.

NOTE: The addition of a front accessory bumper kit may prohibit the installation of a Drive Pro. When mounting the Drive Pro 2" receiver hitch plow on a crew cab (4 person) UTV an accessory 6" power kit may be necessary (Part # 22863).

TO ORDER A PLOW FOR A COMPACT OR AIRPORT TRACTOR, USE THE COMPLETE KIT NUMBER.



COMPACT TRACTOR ORDER INFORMATION AND SPECIFICATIONS

COMPLETE KIT* INCLUDES: Moldboard > Plow Frame > Hydraulic Power Angle Kit > Universal Attachment Plate

Complete Kit* #	Plow Model	Blade Type	Moldboard Length	Moldboard Height	Moldboard Gauge	Vertical Ribs	Plow/Trip Springs	Steel Cutting Edge	Average Width at Full Angle	Angling Rams	Weight [†] Complete
51100	DP-5.0	Full-Trip	5' 0"	22.5"	14 Steel	6	2	¼" x 6"	54.5"	1½" x 10"	330 lb.
51105	DP-6.0	Full-Trip	6' 0"	22.5"	14 Steel	6	2	¼" x 6"	65"	1½" x 10"	350 lb.
51110	DP-6.8	Full-Trip	6' 8"	22.5"	14 Steel	6	2	⅜" x 6"	72"	1½" x 10"	375 lb.
51115	LPLD-7.6	Full-Trip	7' 6"	28"	14 Steel	6	2	⅜" x 6"	81"	1½" x 10"	575 lb.



AIRPORT TRACTOR ORDER INFORMATION AND SPECIFICATIONS

COMPLETE KIT* INCLUDES: Moldboard > Plow Frame > Hydraulic Power Angle/Lift Kit > Universal Mounting Carton

Complete Kit* #	Plow Model	Blade Type	Moldboard Length	Moldboard Height	Moldboard Gauge	Vertical Ribs	Plow Trip Springs	Steel Cutting Edge	Average Width at Full Angle	Angling Rams	Weight [†] Complete
52550	DP-5.0	Full-Trip	5' 0"	22.5"	14 Steel	6	2	¼" x 6"	54.5"	1½" x 10"	330 lb.
52555	DP-6.0	Full-Trip	6' 0"	22.5"	14 Steel	6	2	¼" x 6"	65"	1½" x 10"	350 lb.
52560	DP-6.8	Full-Trip	6' 8"	22.5"	14 Steel	6	2	⅜" x 6"	72"	1½" x 10"	375 lb.
52565	DPSP-7.6	Full-Trip	7' 6"	26"	14 Steel	6	2	⅜" x 6"	81"	1½" x 10"	575 lb.

For available Drive Pro accessories, see pages 17-20

Go to www.meyerproducts.com and visit our EZ-Match Tool for current application recommendations.

PLOWS FOR COMPACT/UTILITY TRACTORS AND SKID STEERS



Lot Pro and Diamond Edge Plows keep your equipment moving all year round.

Extend the capabilities of your tractor or skid steer by adding a Meyer full-trip Lot Pro or a Diamond Edge trip-edge plow. These vehicles have the power to push large amounts of snow and Meyer moldboards are designed to make the task even easier.

The perfect plow for these vehicles:



Compact Tractors



Utility Tractors



Skid Steers

Shown with most popular skid steer package, 8.5 Lot Pro and multi-position wings.



▲ Mounts to skid steer using a Universal plate.



▲ Universal plates are used to mount to compact tractors.



▲ Heavy-duty Agricultural Tractor (H.A.T) mounts are used on utility tractors.



See page 21 for spreaders that fit Tractors.

Full-trip or trip-edge – the choice is yours.



Full-trip allows the entire moldboard to trip when an obstacle is struck. This reduces the wear and tear on the vehicle and driver.



Trip-edge keeps the moldboard upright, while the lower portion gives way when obstacles are struck, so you can keep plowing without losing the load. It absorbs and dissipates the shock caused by obstructions saving damage to the vehicle and driver.



Highway plow inspired black iron.

Lot Pro and Diamond Edge plows feature a robust, tubular steel A-frame and pivot bar to create a stronger, better performing plow.



Create your own configuration.

Our optional multi-position wings can be positioned independently to create a box, scoop or straight blade plow greatly improving the performance and efficiency. Highly recommended for skid steers.

Tall moldboards and aggressive attack angles make it easier to move snow faster than ever before.

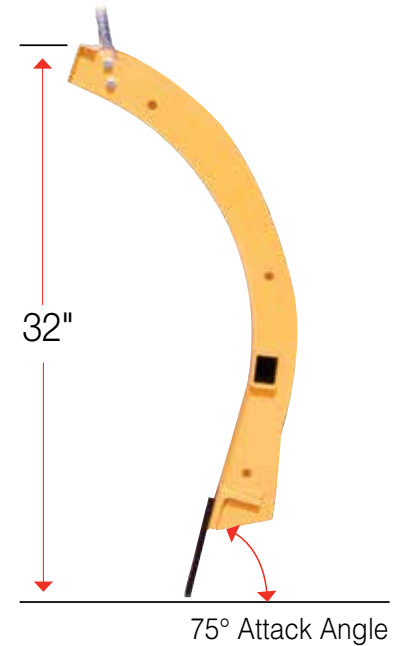

LOT PRO, DIAMOND EDGE MOUNT AND MOVEMENT BY VEHICLE TYPE

Vehicle Type	Mount Type	Angling Method	Up/Down Method
Compact Tractor	Universal attachment plate*	Central hydraulic	Vehicle loader arms
Utility Tractor	Heavy-duty Agricultural Tractor (H.A.T.)*	Central hydraulic or Meyer hydraulic	Meyer hydraulic*
Skid Steers	Universal attachment plate*	Meyer power* or manual angling rams*	Vehicle loader arms

* Included in kit



TO ORDER, USE THE COMPLETE KIT NUMBER.



COMPACT TRACTOR ORDER INFORMATION AND SPECIFICATIONS

COMPLETE KIT* INCLUDES: Moldboard > Plow Frame > Hydraulic Power Angle Kit > Universal Attachment Plate

Complete Kit* #	Model	Blade Type	Moldboard Length	Moldboard Height	Moldboard Gauge	Vertical Ribs	Plow Trip Springs	Steel Cutting Edge	Average Width at Full Angle	Angling Rams	Weight [†] Complete
51120	LP-7.5	Full-Trip	7' 6"	32"	12 Steel	6	4	½" x 6"	81"	1½" x 10"	661 lb.
51125	LP-8.0	Full-Trip	8' 0"	32"	12 Steel	6	4	½" x 6"	86"	1½" x 10"	735 lb.
51130	LP-8.5	Full-Trip	8' 6"	32"	12 Steel	6	4	½" x 6"	92"	1½" x 10"	753 lb.
51135	LP-9.0	Full-Trip	9' 0"	32"	12 Steel	6	4	½" x 6"	97"	1½" x 10"	772 lb.
51140	RP-32-9.0	Full-Trip	9' 0"	32"	10 Steel	6	6	½" x 6"	97"	2" x 12"	845 lb.
51145	RP-32-10.0	Full-Trip	10' 0"	32"	10 Steel	6	6	½" x 6"	103"	2" x 12"	884 lb.

[†] Weight without mount and clevis.



UTILITY TRACTORS ORDER INFORMATION AND SPECIFICATIONS

COMPLETE KIT* INCLUDES: Moldboard > Plow Frame > Hydraulic Power Angle/Lift Kit > Universal Mounting Carton

Complete Kit* #		Model	Blade Type	Moldboard Length	Moldboard Height	Moldboard Gauge	Vertical Ribs	Plow Trip Springs	Steel Cutting Edge	Average Width at Full Angle	Angling Rams	Weight [†] Complete
Kit w/ E-58 Hydraulic**	OR Kit w/ Central Hydraulic**											
52455	52475	LP-8.0	Full-Trip	8' 0"	32"	12 Steel	6	4	½" x 6"	86"	1½" x 10"	947 lb.
52465	52485	LP-9.0	Full-Trip	9' 0"	32"	12 Steel	6	4	½" x 6"	97"	1½" x 10"	984 lb.

** Must choose between Central Hydraulic or Meyer E-58 Hydraulic to power plow.

[†] Weight without mount and clevis. Weights calculated using moldboard and plow kit containing an E-58H hydraulic unit. Subtract 40 lbs. when purchasing a plow kit containing central hydraulics only.



SKID STEER ORDER INFORMATION AND SPECIFICATIONS

COMPLETE KIT* INCLUDES: Moldboard > Plow Frame > Hydraulic Power Angle Kit > Universal Attachment Plate

Complete Kit* #	Model	Blade Type	Moldboard Length	Moldboard Height	Moldboard Gauge	Vertical Ribs	Plow Trip Springs	Steel Cutting Edge	Average Width at Full Angle	Angling Rams	Weight [†] Complete
51120	LP-7.5	Full-Trip	7' 6"	32"	12 Steel	6	4	½" x 6"	81"	1½" x 10"	661 lb.
51125	LP-8.0	Full-Trip	8' 0"	32"	12 Steel	6	4	½" x 6"	86"	1½" x 10"	735 lb.
51130	LP-8.5	Full-Trip	8' 6"	32"	12 Steel	6	4	½" x 6"	92"	1½" x 10"	753 lb.
51135	LP-9.0	Full-Trip	9' 0"	32"	12 Steel	6	4	½" x 6"	97"	1½" x 10"	772 lb.
51140	RP-32-9.0	Full-Trip	9' 0"	32"	10 Steel	6	6	½" x 6"	97"	2" x 10"	845 lb.
51145	RP-32-10.0	Full-Trip	10' 0"	32"	10 Steel	6	6	½" x 6"	103"	2" x 10"	884 lb.

[†] Weight without mount and clevis.



TO ORDER, USE THE COMPLETE KIT NUMBER.



COMPACT TRACTOR ORDER INFORMATION AND SPECIFICATIONS

COMPLETE KIT* INCLUDES: Moldboard > Plow Frame > Hydraulic Power Angle Kit > Universal Attachment Plate

Complete Kit* #	Model	Blade Type	Moldboard Length	Moldboard Height	Moldboard Gauge	Vertical Ribs	Plow Trip Springs	Steel Cutting Edge	Average Width at Full Angle	Angling Rams	Weight† Complete
51150	DE2-7.5	Trip-Edge	7'6"	32.5"	12 Steel	6	4	½" x 6"	82"	1½" x 10"	745 lb.
51155	DE2-8.0	Trip-Edge	8'0"	32.5"	12 Steel	6	4	½" x 6"	87"	1½" x 10"	762 lb.
51160	DE2-8.5	Trip-Edge	8'6"	32.5"	12 Steel	6	4	½" x 6"	92"	1½" x 10"	780 lb.
51165	DE2-9.0	Trip-Edge	9'0"	32.5"	12 Steel	6	4	½" x 6"	98"	1½" x 10"	795 lb.

* Weight without mount and clevis.



UTILITY TRACTORS ORDER INFORMATION AND SPECIFICATIONS

COMPLETE KIT* INCLUDES: Moldboard > Plow Frame > Hydraulic Power Angle/Lift Kit > Universal Mounting Carton

Complete Kit* #		Model	Blade Type	Moldboard Length	Moldboard Height	Moldboard Gauge	Vertical Ribs	Plow Trip Springs	Steel Cutting Edge	Average Width at Full Angle	Angling Rams	Weight† Complete
Kit w/ E-58 Hydraulic**	OR Kit w/ Central Hydraulic**											
52495	52515	DE2-8.0	Trip-Edge	8'0"	32.5"	12 Steel	6	4	½" x 6"	87"	1½" x 10"	970 lb.
52505	52525	DE2-9.0	Trip-Edge	9'0"	32.5"	12 Steel	6	4	½" x 6"	98"	1½" x 10"	1,003 lb.

** Must choose between Central Hydraulic or Meyer E-58 Hydraulic to power plow.

† Weight without mount and clevis. Weights calculated using moldboard and plow kit containing an E-58H hydraulic unit. Subtract 40 lbs. when purchasing a plow kit containing central hydraulics only.



SKID STEER ORDER INFORMATION AND SPECIFICATIONS

COMPLETE KIT* INCLUDES: Moldboard > Plow Frame > Hydraulic Power Angle Kit > Universal Attachment Plate

Complete Kit* #	Model	Blade Type	Moldboard Length	Moldboard Height	Moldboard Gauge	Vertical Ribs	Plow Trip Springs	Steel Cutting Edge	Average Width at Full Angle	Angling Rams	Weight† Complete
51150	DE2-7.5	Trip-Edge	7'6"	32.5"	12 Steel	6	4	½" x 6"	82"	1½" x 10"	745 lb.
51155	DE2-8.0	Trip-Edge	8'0"	32.5"	12 Steel	6	4	½" x 6"	87"	1½" x 10"	762 lb.
51160	DE2-8.5	Trip-Edge	8'6"	32.5"	12 Steel	6	4	½" x 6"	92"	1½" x 10"	780 lb.
51165	DE2-9.0	Trip-Edge	9'0"	32.5"	12 Steel	6	4	½" x 6"	98"	1½" x 10"	795 lb.

* Weight without mount and clevis.

For available Lot Pro and Diamond Edge accessories, see pages 17-20

PLOW ACCESSORIES



Cutting Edges and Curb Guards

Full-trip Steel Cutting Edges — Scientifically designed to meet the demands of a tough environment. Our unique, heat-treated edges meet exacting specifications derived from years of testing to provide long-lasting performance. Pre-drilled, ready for installation. Sold as complete kits or separately as required. Complete kits come with all hardware in order to install.*

Bottom-trip Steel Cutting Edges — Scientifically designed to meet the demands of a tough environment. Our unique, heat-treated edges meet exacting specifications derived from years of testing to provide long-lasting performance. Reversible to extend life; once a side is worn, reverse the cutting edge for extended use. Pre-drilled ready for installation. Cutting edges are sold as complete kits or separately as required. Complete kits come with all hardware in order to install.*

Full-trip Carbide Cutting Edges — Heavy-duty, carbide-tipped cutting edges significantly extend cutting edge life and deliver superior scraping performance. Pre-drilled ready for installation. Sold as complete kits or separately as required. Complete kits come with all hardware in order to install.*

Bottom-trip Rubber Cutting Edge Kit — Rubber cutting edges are designed to eliminate noise while providing maximum protection to decorative surfaces. Our 1.5" thick edge is formulated for long life. Reversible to extend cutting edge life, once a side is worn, reverse the cutting edge for extended use. Pre-drilled ready for installation. Cutting edges are sold as complete kits or separately as required. Complete kits come with all hardware in order to install.*

Bottom-trip Polyurethane Cutting Edge Kit — Provides the rigidity of steel edges and the noise reduction of rubber edges; all while protecting decorative surfaces. Our one-inch thick edge is formulated for long life. Reversible to extend the life, once a side is worn, reverse the cutting edge for extended use. Pre-drilled ready for installation. Cutting edges are sold as complete kits or separately as required. Complete kits come with all hardware in order to install.*

Full-trip Rubber Cutting Edge Kit — Eliminates noise while providing maximum protection to sensitive surfaces. Our 1.5" thick edge is formulated for long life. Reversible to extend cutting edge life, once a side is worn, reverse it for extended use. Pre-drilled ready for installation. Cutting edges are sold as complete kits or separately as required. Complete kits come with all hardware in order to install.*

Full-trip Polyurethane Cutting Edge Kit — Provides the rigidity of steel edges and the noise reduction of rubber edges, while protecting sensitive surfaces. Our one-inch thick edge is formulated for long life. Pre-drilled ready for installation. Cutting edges are sold as complete kits or separately as required. Complete kits come with all hardware in order to install.*

See Quick Accessories Guide for exact part numbers on pages 17-20. Visit www.meyerproducts.com for current plow accessory information.

Curb Guards — Made with 3/8" steel, easy to install with pre-drilled hole pattern, curved and contoured for a perfect fit. Comes as a set of two (2) and are interchangeable/reversible side to side. Ships with mounting hardware and installation instructions for an easy install. Part #08344 LP/SV 8.5 and up/DAG



Deflectors

Meyer Heavy-duty Molded Deflectors — Made of rigid polyethylene, deflectors reduce blow-back on the windshield, and accentuate the snow rolling action of the plow. The 45 degree angle end-cut helps throw snow more precisely for a quicker, cleaner scrape. Complete deflector kits come ready to install with hardware bag and steel mounting belt.*



Meyer Rubber Snow Deflectors — Made of pliable heavy duty rubber, the deflector keeps snow flume down and away from the windshield and accentuates the snow rolling action of the plow. Complete deflector kits come ready to install with hardware bag and steel mounting belt.*



Meyer Poly Snow Deflectors — Made of pliable poly, the deflector keeps snow flume down and away from the windshield and accentuates the snow rolling action of the plow. Complete deflector kits come ready to install with hardware bag and steel mounting belt.*

Get the Controller That's Right for You

Meyer offers pistol grip, joystick or touchpad controllers that are illuminated for nighttime operation. Each controller can be handheld, mounted on the dash or floor, or use a leg strap, depending on your requirements.

Hands Free Plowing (HFP) Mode — All Meyer pistol grip and joystick controllers feature the HFP mode. When activated, shifting into and out of reverse controls the up/down movement of the moldboard. To activate Back-dragging Mode, press the HFP button once and the moldboard automatically lowers when the vehicle is shifted into reverse and raises when the vehicle is shifted out of reverse. To activate the Forward Plowing Mode press the HFP button a second time and the moldboard automatically raises when the vehicle is shifted into reverse and lowers when the vehicle is shifted out of reverse. To deactivate HFP, press the button a third time.



Pistol Grip Controller with HFP (Standard) Meyer pistol grip controllers, featuring one button functionality and self diagnostics, ensure worry-free operation of all plowing functions. Ergonomic design is comfortable and easy to use.

Joystick Controller with HFP — Operates Pro Series straight blade plows. HFP allows you to automatically raise or lower the plow. The Meyer Joystick controller employs one button functionality. In addition, this controller features an illuminated joystick and buttons, self diagnostics and is compatible with all Meyer Pro Series plow systems.
Part #22790X Joystick / Part #22265C Leg Strap

Joystick Cradle Mount — Custom designed for the Meyer Joystick Controller. Locks the joystick into place, docking the unit in a safe and useful position. Mounts virtually anywhere on the dashboard or mounts to the Floor Mount (sold separately). Installation is quick and easy. Joystick Cradle Mount comes with mounting tape and hardware for an easy, do-it-yourself install. Part #22799

Pistol Grip Cradle Mount — Custom designed for any Meyer Pistol Grip Controller. Holds the Pistol Grip in place, docking the unit in a safe and useful position. It will mount to the dashboard or Floor Mount (sold separately). Installation is quick and easy. Unit comes with mounting tape and hardware for an easy, do-it-yourself install. Part #22798

Wings/Trip Dampener

Multi-Position Wings—Meyer EZ-Wing™ — Greatly improve the performance and efficiency of your Lot Pro moldboard. Each wing can be positioned independently to create a box, scoop or straight blade configuration (up to nine positions) with the pull of a pin. Adds nearly 2.5 feet of overall length to Lot Pro moldboards. Fits all Lot Pro moldboards 7.5' through 10.0'. Installs with no moldboard modification. Comes as a set of two (2), one each, left and right. Hardware and mounting instructions included.
Part #08380 Multi-Wing For Lot Pro Steel and Poly



Fixed-Position 45 Degree Wings — Extends the moldboard 10" on each side. Fits all Lot Pro moldboards 7.5' through 10.0'. Installs with no moldboard modification. Comes as a set of two (2), one each, left and right. Hardware and mounting instructions included. Part #08375 Fixed-Wing For Lot Pro Steel and Poly

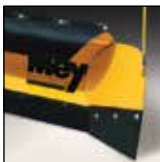

Fixed-Position 45 Degree Wings — Extends the moldboard 10" on each side. Fits all C-Series and ST Steel moldboards 7.5' through 9.0'. Comes as a set of two (2), one each, left and right. Hardware and mounting instructions included. Part #08888 (C, ST)

Box Wings — Converts all steel and poly Lot Pro and AG moldboards into a push plow. Features reinforced design with heavy-duty rubber cutting edge. Installs with no moldboard modification. Fits all Lot Pro moldboards 7.5' through 10.0'. Comes as a set of two (2), one each, left and right. Hardware and mounting instructions included.
Part #08104 (LP, LPP)



Trip-Dampener Kit — Helps cushion the impact of the moldboard's tripping action, both the forward and return actions, without eliminating or diminishing the tripping action which is an integral feature of a full-trip moldboard. Dampening the impact of the tripping action saves wear and tear on the operator and the vehicle. The Trip-dampening System is easy to install and comes with hardware and installation instructions. (Lot Pro series only)



Plow Size	Complete Kit* Part #	Left Side Part #	Right Side Part #
7.5 ft. Steel/Poly	08243	08251	08252
8.0 ft. Steel/Poly/SS	08243	08251	08252
8.5 ft. Steel/Poly	08243	08251	08252
9.0 ft. Steel/Poly/SS	08243	08251	08252

* Complete kit includes left and right.

Accessories

Central Hydraulic Kit — Allows you to plumb the plow directly to the vehicle's hydraulic system. Kit comes complete with two (2) municipal duty angling rams, one (1) lift cylinder and a complete hardware kit and installation instructions. (Hoses provided by installer.)
Part #08897 Full Frame Tractor
Part #08870 Skid Steer/Compact Tractor

Plow Markers — Allow the operator to see the edge of his plow from the cab providing maximum visibility for increased performance and safety. Made from solid tubing, markers are flexible yet durable to withstand the winter environment. Markers are ready to install, no drilling is necessary. Markers are shipped two (2) per set and include all mounting hardware and instructions for easy do-it-yourself installation.
Part #09917 Fits: DP, LP, DE, DE2, AG, DAG, RP series
Part #09916 Fits: TM, ST, STL, C, HM series
Part # 09916C Fits: PP series



Driveway Markers — Markers are 4' long, made of sturdy 1/4" fiberglass to withstand winter elements. They are flexible, capable of bending virtually in half, then returning to their original shape. Built in highly reflective fluorescent orange, along with a specialized reflective tape, these markers are highly visible during a storm or after dark. Markers are shipped in a bundle of 100.
Part #03240 Driveway Markers
Part #03242 Driveway Marker Insertion Tool
Part #03243 Driveway Marker Display Stand



See Quick Accessories Guide for exact part numbers on pages 17-20. Visit www.meyerproducts.com for current plow accessory information.

PLOW ACCESSORIES

Oils – Paints – Grease

Meyer Sno-Flo™ Industrial Paint — Our specially formulated paint is designed to improve snow-rolling action and withstand the harsh operational environment. Meyer Yellow, Black and White Primer is available in aerosol spray cans (12/case) and Meyer Yellow brushable paint is available in 1 quart cans (4/case) that can be shipped via UPS.

Part #08755 Brush Yellow (4/1qt.cans/UPS)
Part #08677 Spray Case Yellow (12cans/case)
Part #08676 Spray Case Black (12cans/case)



Meyer M1 Hydraulic Fluid — Keep your hydraulic unit operating at factory specs by using OEM M1 Hydraulic Fluid. Meyer M1 Hydraulic fluid is scientifically formulated to withstand extreme temperatures. Meyer's exclusive additives maximize performance and increase the longevity of the complete operating system. M1 Hydraulic Fluid is guaranteed to perform at temperatures of -40°F. Meyer recommends that you drain the M1 Hydraulic fluid in the spring, fill and store the unit with Hydra-Flush over the summer then refill with new M1 Hydraulic fluid in the fall. Note: using other hydraulic fluids or additives voids your warranty and may permanently damage your unit. Comes in cases of 12 easy pour bottles. Part #15487 (case/12)



Meyer M2 Hydraulic Flush — Keeping your hydraulic unit internally clean is as important as keeping your truck engine clean. Meyer's M2 Hydraulic Flush is designed to scrub the internal components and flush away any impurities that may have developed in the system. Our exclusively designed M2 Flush performs without harming seals, connectors or hydraulic ports. Meyer recommends that you drain the M1 Hydraulic fluid in the spring, fill and store the unit with Hydra-Flush over the summer then refill with new M1 Hydraulic fluid in the fall. Comes in cases of 12 easy pour bottles. Part #15902 (case/12)



Meyer Dielectric Grease — Protect your electrical system from the harsh winter elements with Meyer's dielectric grease. Specially formulated to coat and protect electrical connections from deteriorating elements such as salt and road grime. Meyer recommends coating all electrical connections prior to winter and each time you reconnect to ensure optimal performance. Grease comes one (1) each, 2.7 oz tube. Part #15632



Meyer Coolube — Multipurpose, non-soap based grease provides better lubrication in harsh conditions, higher speeds and lower temperatures. Holds up over a wider temperature range (-40°F to 440°F). Works wet or dry. Sold in cases of 10 tubes; tube fits a standard grease gun. Part #15182



Meyer Chain and Cable Lube — This transparent, heavy-duty dry film lubricant is formulated to lubricate, preserve and protect chains and cables. Once applied, the solvent evaporates leaving behind a film that will not attract dust or wash off. Sold in cases of 12 aerosol cans. Part #15184



Meyer Coolube Aerosol Grease — Has the same features of our standard lube in a convenient spray can. Formulated to remain on metal surfaces longer than ordinary greases. Sold in cases of 12 aerosol cans. Part #15186



QUICK ACCESSORIES REFERENCE GUIDE

PRO SERIES PLOWS – Path Pro, Drive Pro and Lot Pro

DESCRIPTION	PP 50"	PP 60"	PP 72"	DP 5' 0"	DP 6' 0"	DP 6' 8"	DP 7'6" SP/DP 7'6"	LP 7.5	LP 8.0	LP 8.5	LP 9.0 LPHD 9.0	LP 10.0
CUTTING EDGES												
STEEL COMPLETE KIT	08297	08298	08308	08172	08175	08176	08178	08296	08180	08182	08185	08216
STEEL EDGE ONLY	09337	09335	09418	09319	09271	09277	09796	09797	09133	09134	07259	07235
HARDWARE ONLY	08222	08222	08222	08222	08222	08222	08222	08222	08222	08222	08223	08223
POLY COMPLETE KIT	08303	08304	08310	08320	08116	08277	08119	08119	08160	08162	08164	08167
POLY EDGE ONLY	09367	09368	09421	09424	09281	12708	09224	09224	09222	09221	09206	09284
STRAP ONLY	13382	13383	13430	13432	13055	12707	13058	13058	13060	13062	13064	13066
HARDWARE ONLY	08224	08224	08224	08224	08224	08224	08224	08224	08224	08224	08225	08225
RUBBER COMPLETE KIT	08301	08302	08309	08319	08237	08236	08189	08189	08190	08191	08192	08193
RUBBER EDGE ONLY	09365	09366	09420	09423	13077	13076	12436	12436	12437	12438	12439	12440
HARDWARE ONLY	08224	08224	08224	08224	08224	08224	08224	08224	08224	08224	08225	08225
BAR STRAP (V PLOWS ONLY)	N/A	N/A	N/A	N/A	N/A	N/A	N/A	N/A	N/A	N/A	N/A	N/A
CARBIDE CUTTING EDGE KIT	N/A	N/A	N/A	N/A	N/A	N/A	N/A	N/A	N/A	N/A	N/A	08780
CARBIDE CUTTING EDGE ONLY	N/A	N/A	N/A	N/A	N/A	N/A	N/A	N/A	N/A	N/A	N/A	07198
HARDWARE ONLY	N/A	N/A	N/A	N/A	N/A	N/A	N/A	N/A	N/A	N/A	N/A	08225
DEFLECTORS												
MOLDED KIT COMPLETE	N/A	N/A	N/A	N/A	12036	13071	12039	12039	12040	12041	12042	12043
MOLDED DEFLECTOR	N/A	N/A	N/A	N/A	12044	13072	12047	12047	12048	12049	12050	12051
STRAP ONLY	N/A	N/A	N/A	N/A	12028	12707	12487	12487	12497	12498	12031	12032
HARDWARE ONLY	N/A	N/A	N/A	N/A	08612	08612	08614	08614	08614	08614	08614	08614
RUBBER KIT COMPLETE	N/A	N/A	N/A	08238	08103	08107	08109	08109	08111	08112	08113	08114
RUBBER DEFLECTOR	N/A	N/A	N/A	13087	13046	13048	13050	13050	13051	13052	13053	13054
STRAP ONLY	N/A	N/A	N/A	13088	12028	12707	12487	12487	12497	12498	12031	12032
HARDWARE ONLY	N/A	N/A	N/A	08612	08612	08612	08614	08614	08614	08614	08614	08614
POLY KIT COMPLETE	13368	13369	13418	N/A	N/A	N/A	12078	12078	12024	12025	12123	12124
POLY DEFLECTOR	13376	13377	13429	N/A	N/A	N/A	12073	12073	12009	12014	12118	12119
STRAP ONLY	13372	13373	13424	N/A	N/A	N/A	12487	12487	12497	12498	12031	12032
HARDWARE ONLY	08612	08612	08612	N/A	N/A	N/A	08614	08614	08614	08614	08614	08614
SHOES												
SHOE EACH, UNLESS NOTED	09369	09369	09369	09127	09127	09127	09127	09362	09362	09362	09362	09362
WINGS												
FIXED 45 DEGREE	N/A	N/A	N/A	N/A	N/A	N/A	N/A	08375	08375	08375	08375	08375
FIXED BOX	N/A	N/A	N/A	N/A	N/A	N/A	N/A	08104	08104	08104	08104	08104
MULTI POSITION	N/A	N/A	N/A	N/A	N/A	N/A	N/A	08380	08380	08380	08380	08380
CURB GUARDS												
PAIR/KIT	N/A	N/A	N/A	N/A	N/A	N/A	N/A	08344	08344	08344	08344	08344
CONTROLLERS AND HOLDERS												
TOUCH PAD	N/A	N/A	N/A	22154	22154	22154	22154	22154	22154	22154	22154	22154
JOYSTICK WITH HFP	N/A	N/A	N/A	22790X	22790X	22790X	22790X	22790X	22790X	22790X	22790X	22790X
PISTOL GRIP WITH HFP	N/A	N/A	N/A	22690DC	22690DC	22690DC	22690DC	22690DC	22690DC	22690DC	22690DC	22690DC
PISTOL GRIP DELUXE WITH HFP	N/A	N/A	N/A	22695DC	22695DC	22695DC	22695DC	22695DC	22695DC	22695DC	22695DC	22695DC
LEG STRAP	N/A	N/A	N/A	22265C	22265C	22265C	22265C	22265C	22265C	22265C	22265C	22265C
PISTOL GRIP CRADLE MOUNT	N/A	N/A	N/A	22798	22798	22798	22798	22798	22798	22798	22798	22798
JOYSTICK CRADLE MOUNT	N/A	N/A	N/A	22799	22799	22799	22799	22799	22799	22799	22799	22799
45° CRADLE ADAPTER	N/A	N/A	N/A	22815	22815	22815	22815	22815	22815	22815	22815	22815
10" FLOOR MOUNT	N/A	N/A	N/A	22801	22801	22801	22801	22801	22801	22801	22801	22801
20" FLOOR MOUNT	N/A	N/A	N/A	22844	22844	22844	22844	22844	22844	22844	22844	22844
PLOW MARKERS												
2 PER PACK	09916C	09916C	09916C	09917	09917	09917	09917	09917	09917	09917	09917	09917
CART												
DRIVE PRO	N/A	N/A	N/A	QMB-DP	QMB-DP	QMB-DP	N/A	N/A	N/A	N/A	N/A	N/A
EZ MOUNT PLUS & MDII	N/A	N/A	N/A	N/A	N/A	N/A	QMB-JB	QMB-JB	QMB-JB	QMB-JB	QMB-JB	QMB-JB
EZ MOUNT PLUS & MDII LIFT FRAME	N/A	N/A	N/A	N/A	N/A	N/A	QME-JB	QME-JB	QME-JB	QME-JB	QME-JB	QME-JB
EZ MOUNT CLASSIC	N/A	N/A	N/A	N/A	N/A	N/A	QMB-ST	QMB-ST	QMB-ST	QMB-ST	QMB-ST	QMB-ST
EZ MOUNT CLASSIC LIFT FRAME	N/A	N/A	N/A	N/A	N/A	N/A	QME-ST	QME-ST	QME-ST	QME-ST	QME-ST	QME-ST
PAINT												
BRUSH YELLOW (4-1 QT. CANS/CASE)	08755	08755	08755	08755	08755	08755	08755	08755	08755	08755	08755	08755
SPRAY CASE YELLOW (12 CANS/CASE)	08677	08677	08677	08677	08677	08677	08677	08677	08677	08677	08677	08677
SPRAY CASE BLACK (12 CANS/CASE)	08676	08676	08676	08676	08676	08676	08676	08676	08676	08676	08676	08676

QUICK ACCESSORIES REFERENCE GUIDE

PRO SERIES PLOWS – Diamond Edge

DESCRIPTION	DE2 7.5	DE2 8.0	DE2 8.5	DE2 9.0	DE 7.5	DE 8.0	DE 8.5	DE 9.0
CUTTING EDGES								
STEEL COMPLETE KIT	08179	08181	08183	08215	08179	08181	08183	08215
STEEL EDGE ONLY	84127	84128	84129	84130	84127	84128	84129	84130
HARDWARE ONLY	08223	08223	08223	08223	08223	08223	08223	08223
POLY COMPLETE KIT	08159	08161	08163	08165	08159	08161	08163	08165
POLY EDGE ONLY	09202	09203	09204	09301	09202	09203	09204	09301
STRAP ONLY	13059	13061	13063	13065	13059	13061	13063	13065
HARDWARE ONLY	08225	08225	08225	08225	08225	08225	08225	08225
RUBBER COMPLETE KIT	08218	08219	08220	08221	08218	08219	08220	08221
RUBBER EDGE ONLY	09308	09309	09310	09311	09308	09309	09310	09311
HARDWARE ONLY	08225	08225	08225	08225	08225	08225	08225	08225
BAR STRAP (V PLOWS ONLY)	N/A	N/A	N/A	N/A	N/A	N/A	N/A	N/A
CARBIDE CUTTING EDGE KIT	N/A	N/A	N/A	N/A	N/A	N/A	N/A	N/A
CARBIDE CUTTING EDGE ONLY	N/A	N/A	N/A	N/A	N/A	N/A	N/A	N/A
HARDWARE ONLY	N/A	N/A	N/A	N/A	N/A	N/A	N/A	N/A
DEFLECTORS								
MOLDED KIT COMPLETE	12039	12040	12041	12042	12039	12040	12041	12042
MOLDED DEFLECTOR	12047	12048	12049	12050	12047	12048	12049	12050
STRAP ONLY	12487	12497	12498	12031	12487	12497	12498	12031
HARDWARE ONLY	08614	08614	08614	08614	08614	08614	08614	08614
RUBBER KIT COMPLETE	08109	08111	08112	08113	08109	08111	08112	08113
RUBBER DEFLECTOR	13050	13051	13052	13053	13050	13051	13052	13053
STRAP ONLY	12487	12497	12498	12031	12487	12497	12498	12031
HARDWARE ONLY	08614	08614	08614	08614	08614	08614	08614	08614
POLY KIT COMPLETE	N/A	N/A	N/A	N/A	N/A	N/A	N/A	N/A
POLY DEFLECTOR	N/A	N/A	N/A	N/A	N/A	N/A	N/A	N/A
STRAP ONLY	N/A	N/A	N/A	N/A	N/A	N/A	N/A	N/A
HARDWARE ONLY	N/A	N/A	N/A	N/A	N/A	N/A	N/A	N/A
SHOES								
SHOE EACH, UNLESS NOTED	09930	09930	09930	09930	84040	84040	84040	84040
WINGS								
FIXED 45 DEGREE	08110	08110	08110	08110	N/A	N/A	N/A	N/A
FIXED BOX	08104	08104	08104	08104	N/A	N/A	N/A	N/A
MULTI POSITION	08115	08115	08115	08115	N/A	N/A	N/A	N/A
CURB GUARDS								
PAIR/KIT	08344	08344	08344	08344	08344	08344	08344	08344
CONTROLLERS AND HOLDERS								
TOUCH PAD	22154	22154	22154	22154	22154	22154	22154	22154
JOYSTICK WITH HFP	22790X	22790X	22790X	22790X	22790X	22790X	22790X	22790X
PISTOL GRIP WITH HFP	22690DC	22690DC	22690DC	22690DC	22690DC	22690DC	22690DC	22690DC
PISTOL GRIP DELUXE WITH HFP	22695DC	22695DC	22695DC	22695DC	22695DC	22695DC	22695DC	22695DC
LEG STRAP	22265C	22265C	22265C	22265C	22265C	22265C	22265C	22265C
PISTOL GRIP CRADLE MOUNT	22798	22798	22798	22798	22798	22798	22798	22798
JOYSTICK CRADLE MOUNT	22799	22799	22799	22799	22799	22799	22799	22799
45° CRADLE ADAPTER	22815	22815	22815	22815	22815	22815	22815	22815
10" FLOOR MOUNT	22801	22801	22801	22801	22801	22801	22801	22801
20" FLOOR MOUNT	22844	22844	22844	22844	22844	22844	22844	22844
PLOW MARKERS								
2 PER PACK	09917C	09917C	09917C	09917C	09917	09917	09917	09917
CART								
DRIVE PRO	N/A	N/A	N/A	N/A	N/A	N/A	N/A	N/A
EZ MOUNT PLUS & MDII	N/A	N/A	N/A	N/A	N/A	N/A	N/A	N/A
EZ MOUNT PLUS & MDII LIFT FRAME	N/A	N/A	N/A	N/A	N/A	N/A	N/A	N/A
EZ MOUNT CLASSIC	QMB-ST	QMB-ST	QMB-ST	QMB-ST	QMB-ST	QMB-ST	QMB-ST	QMB-ST
EZ MOUNT CLASSIC LIFT FRAME	QME-ST	QME-ST	QME-ST	QME-ST	QME-ST	QME-ST	QME-ST	QME-ST
V PLOW - VECTOR & SUPER V SERIES	N/A	N/A	N/A	N/A	N/A	N/A	N/A	N/A
PAINT								
BRUSH YELLOW (4-1QT. CANS/CASE)	08755	08755	08755	08755	08755	08755	08755	08755
SPRAY CASE YELLOW (12 CANS/CASE)	08677	08677	08677	08677	08677	08677	08677	08677
SPRAY CASE BLACK (12 CANS/CASE)	08676	08676	08676	08676	08676	08676	08676	08676

QUICK ACCESSORIES REFERENCE GUIDE

PRO SERIES PLOWS – Path Pro, Drive Pro and Lot Pro													
DESCRIPTION	PP 50"	PP 60"	PP 72"	DP 5' 0"	DP 6' 0"	DP 6' 8"	DP 7' 6"	DPP 7' 6"	LP 7.5	LP 8.0	LP 8.5	LP 9.0	LP 10.0
GREASE AND OIL													
HYDRAULIC FLUID, QUART (12 CASE)	15487	15487	15487	15487	15487	15487	15487	15487	15487	15487	15487	15487	15487
HYDRAULIC FLUSH, QUART (12 CASE)	15902	15902	15902	15902	15902	15902	15902	15902	15902	15902	15902	15902	15902
DIELECTRIC GREASE	15632	15632	15632	15632	15632	15632	15632	15632	15632	15632	15632	15632	15632
COOLUBE GREASE - CARTRIDGE	15182	15182	15182	15182	15182	15182	15182	15182	15182	15182	15182	15182	15182
CHAIN AND CABLE LUBE - AEROSOL	15184	15184	15184	15184	15184	15184	15184	15184	15184	15184	15184	15184	15184
COOLUBE GREASE - AEROSOL	15186	15186	15186	15186	15186	15186	15186	15186	15186	15186	15186	15186	15186
SPRINGS													
EACH	13286	13286	13286	12978	12978	12978	07178	07178	07017	07017	07017	07017	07017
WINCH CRADLE													
EZ MOUNT CLASSIC FOR TM JEEP	N/A	N/A	N/A	N/A	N/A	N/A	N/A	N/A	N/A	N/A	N/A	N/A	N/A
EZ MOUNT CLASSIC FOR TM SERIES	N/A	N/A	N/A	N/A	N/A	N/A	N/A	N/A	N/A	N/A	N/A	N/A	N/A
EZ-MOUNT CLASSIC	N/A	N/A	N/A	N/A	N/A	N/A	16528	16528	16528	16528	16528	16528	16528
EZ MOUNT PLUS OR MDII	N/A	N/A	N/A	N/A	N/A	N/A	16529	16529	16529	16529	16529	16529	16529
2"x2" RECIEVER HITCH - REAR	N/A	N/A	N/A	16542	16542	16542	16542	16542	16542	16542	16542	16542	16542
BRUSH GUARD													
EZ MOUNT CLASSIC FULL FRAME	N/A	N/A	N/A	N/A	N/A	N/A	11558	11558	11558	11558	11558	11558	11558
EZ MOUNT CLASSIC WITH TM 11275 LIFT FRAME	N/A	N/A	N/A	N/A	N/A	N/A	N/A	N/A	N/A	N/A	N/A	N/A	N/A
EZ MOUNT CLASSIC WITH JEEP TM 11545 LIFT FRAME	N/A	N/A	N/A	N/A	N/A	N/A	N/A	N/A	N/A	N/A	N/A	N/A	N/A
EZ MOUNT PLUS	N/A	N/A	N/A	N/A	N/A	N/A	08300	08300	08300	08300	08300	08300	08300
CENTRAL HYDRAULICS													
FULL FRAME TRACTOR	N/A	N/A	N/A	N/A	N/A	N/A	N/A	N/A	08897	08897	08897	08897	08897
COMPACT TRACTOR/SKID STEER	N/A	N/A	N/A	N/A	N/A	N/A	N/A	N/A	08870	08870	08870	08870	08870
LIFT AND MANUAL RAM KITS													
MANUAL RAM (SKID STEERS, TRACTORS)	N/A	N/A	N/A	08872	08872	08872	08872	08872	08872	08872	08872	08872	08872
HYDRAULIC LIFT (TRACTORS)	N/A	N/A	N/A	08299	08299	08299	08299	08299	08299	08299	08299	08299	08299
HYDRAULIC UNIT													
STANDARD STRAIGHT BLADE UNIT	N/A	N/A	N/A	15995	15995	15995	15995	15995	15995	15995	15995	15995	15995
OUT FRONT UNIT (ROAD PRO)	N/A	N/A	N/A	N/A	N/A	N/A	N/A	N/A	N/A	N/A	N/A	N/A	N/A
SUPER V	N/A	N/A	N/A	N/A	N/A	N/A	N/A	N/A	N/A	N/A	N/A	N/A	N/A
MEYER EQUIPMENT LOCK	N/A	N/A	N/A	07695	07695	07695	07695	07695	07695	07695	07695	07695	07695
HYDRAULIC COVER													
E-58 COVER	N/A	N/A	N/A	15630	15630	15630	15630	15630	15630	15630	15630	15630	15630
E-58 LOCKING STRAP	N/A	N/A	N/A	15631	15631	15631	15631	15631	15631	15631	15631	15631	15631
E-70	N/A	N/A	N/A	N/A	N/A	N/A	N/A	N/A	N/A	N/A	N/A	N/A	N/A
V-70 COVER	N/A	N/A	N/A	N/A	N/A	N/A	N/A	N/A	N/A	N/A	N/A	N/A	N/A
V-70 LOCKING STRAP	N/A	N/A	N/A	N/A	N/A	N/A	N/A	N/A	N/A	N/A	N/A	N/A	N/A
V-71 COVER	N/A	N/A	N/A	N/A	N/A	N/A	N/A	N/A	N/A	N/A	N/A	N/A	N/A
V-71 LOCKING STRAP	N/A	N/A	N/A	N/A	N/A	N/A	N/A	N/A	N/A	N/A	N/A	N/A	N/A
E-72 COVER	N/A	N/A	N/A	N/A	N/A	N/A	15645	15645	15645	15645	15645	15645	15645
E-72 LOCKING STRAP	N/A	N/A	N/A	N/A	N/A	N/A	16534	16534	16534	16534	16534	16534	16534
LIGHTS													
LIGHTS ONLY, NITE SABER II (PAIR)	N/A	N/A	N/A	07549	07549	07549	07549	07549	07549	07549	07549	07549	07549
LIGHTS AND MODULES, NITE SABER II (NEW INSTALLATION)	N/A	N/A	N/A	07550	07550	07550	07550	07550	07550	07550	07550	07550	07550
LIGHTS ONLY, NITE SABER I (PAIR)	N/A	N/A	N/A	07305	07305	07305	07305	07305	07305	07305	07305	07305	07305
LIGHTS AND MODULES, NITE SABER I (NEW INSTALLATION)	N/A	N/A	N/A	07234	07234	07234	07234	07234	07234	07234	07234	07234	07234
FENDER MOUNTING BRACKETS, ROAD PRO & HM SERIES; 2 REQ'D	N/A	N/A	N/A	N/A	N/A	N/A	N/A	N/A	N/A	N/A	N/A	N/A	19168

QUICK ACCESSORIES REFERENCE GUIDE

PRO SERIES PLOWS – Diamond Edge

DESCRIPTION	DE /DE2 7.5	DE /DE2 8.0	DE /DE2 8.5	DE /DE2 9.0
GREASE AND OIL				
HYDRAULIC FLUID, QUART (12 CASE)	15487	15487	15487	15487
HYDRAULIC FLUSH, QUART (12 CASE)	15902	15902	15902	15902
DIELECTRIC GREASE	15632	15632	15632	15632
COOLUBE GREASE - CARTRIDGE	15182	15182	15182	15182
CHAIN AND CABLE LUBE - AEROSOL	15184	15184	15184	15184
COOLUBE GREASE - AEROSOL	15186	15186	15186	15186
SPRINGS				
EACH	07017	07017	07017	07017
WINCH CRADLE				
EZ MOUNT CLASSIC FOR TM JEEP	N/A	N/A	N/A	N/A
EZ MOUNT CLASSIC FOR TM SERIES	N/A	N/A	N/A	N/A
EZ-MOUNT CLASSIC	16528	16528	16528	16528
EZ MOUNT PLUS OR MDII	16529	16529	16529	16529
2"X2" RECIEVER HITCH - REAR	16542	16542	16542	16542
BRUSH GUARD				
EZ MOUNT CLASSIC FULL FRAME	N/A	N/A	N/A	N/A
EZ MOUNT CLASSIC WITH TM 11275 LIFT FRAME	N/A	N/A	N/A	N/A
EZ MOUNT CLASSIC WITH JEEP TM 11545 LIFT FRAME	N/A	N/A	N/A	N/A
EZ MOUNT PLUS	08300	08300	08300	08300
CENTRAL HYDRAULICS				
FULL FRAME TRACTOR	08897	08897	08897	08897
COMPACT TRACTOR/SKID STEER	08870	08870	08870	08870
LIFT AND MANUAL RAM KITS				
MANUAL RAM (SKID STEERS, TRACTORS)	08872	08872	08872	08872
HYDRAULIC LIFT (TRACTORS)	08229	08229	08229	08229
HYDRAULIC UNIT				
STANDARD STRAIGHT BLADE UNIT	15995	15995	15995	15995
OUT FRONT UNIT (ROAD PRO)	N/A	N/A	N/A	N/A
SUPER V	N/A	N/A	N/A	N/A
MEYER EQUIPMENT LOCK	07695	07695	07695	07695
HYDRAULIC COVER				
E-58 COVER	15630	15630	15630	15630
E-58 LOCKING STRAP	15631	15631	15631	15631
E-70	N/A	N/A	N/A	N/A
V-70 COVER	N/A	N/A	N/A	N/A
V-70 LOCKING STRAP	N/A	N/A	N/A	N/A
V-71 COVER	N/A	N/A	N/A	N/A
V-71 LOCKING STRAP	N/A	N/A	N/A	N/A
E-72 COVER	15645	15645	15645	15645
E-72 LOCKING STRAP	15634	15634	15634	15634
LIGHTS				
LIGHTS ONLY, NITE SABER II (PAIR)	07549	07549	07549	07549
LIGHTS AND MODULES, NITE SABER II (NEW INSTALLATION)	07550	07550	07550	07550
LIGHTS ONLY, NITE SABER I (PAIR)	07305	07305	07305	07305
LIGHTS AND MODULES, NITE SABER I (NEW INSTALLATION)	07234	07234	07234	07234
FENDER MOUNTING BRACKETS, ROAD PRO & HM SERIES; 2 REQ'D	N/A	N/A	N/A	N/A

SPREADERS FOR YOUR OFF-ROAD VEHICLE

SPREADERS FOR YOUR OFF-ROAD VEHICLE

**If it has four wheels,
we have the spreader
for it.**



BL-125
Part# 31125

ATV Spreader

Economical, full-functioning spreader that fits most ATVs using a universal mount.

FEATURES:

- Poly hopper construction for long life
- Internal filtering screen breaks up large chunks
- Poly weather cap keeps material dry
- Adjustable salt shield for spread pattern adjustment
- Elevated motor ensures reliable performance
- Impeller spinner shaft spreads material exactly where you need it

SPECS:

Capacity: 128 lbs.
Materials: Bagged rock salt, free-flowing granular material
Construction: Polyethylene hopper
Spread Width: 1.09-3.28 yds.
Warranty: 1 year



LPV
Part# 63395

UTV Spreader

Low profile design is perfect for UTVs and is powered by a powerful 12V electric motor.

FEATURES:

- Stainless steel construction for long life
- Internal and external baffles for exact material placement
- Belt over chain material delivery system precise material flow
- Slot and tab construction is stronger and more precise fit

SPECS:

Capacity: .3 cu yds, 11.5 cu yds.
Materials: salt, 50/50 salt-sand and sand, seed, fertilizer
Construction: Polyethylene hopper
Spread Width: 1.09-3.28 yds.
Warranty: 1 year

Part #s 63394 (.3 cubic yds.); 63395 (11.5 cubic ft.)



BL-400
Part# 36100
*Shown with optional
3-point hitch mount*

UTV/Tractor Spreaders

Blaster and BL Spreaders are perfect for small to medium size jobs. They attach to any utility vehicle using a 5cm receiver hitch.

FEATURES:

- Polyurethane construction resists corrosion
- Variable speed controller minimizes material usage
- Multiple auger options available
- Powerful direct drive motor grinds through chunks of material
- Locking straps keep moisture and contamination out of the hopper

SPECS:

Capacity: 6.3 cu ft., 6.5 cu ft.
Materials: salt, 50/50 salt-sand and sand
Construction: Polyethylene hopper
Spread Width: 1.09 - 8.31 yds.
Warranty: 1 year BL-series;
3/5 Blaster series

Part # 36500 – 3-point hitch mount fits:
BL Series (240 & 400) and Blasters (350 & 750R)

Blaster 350S
Part# 37000
with vibrator kit



MATE
Part# 38000



Tractor Spreader

Turns tractors into high performance salt spreading machines. Strap mounts allows for easy installation and removal from vehicle.

FEATURES:

- Polyurethane construction resists corrosion
- Direct drive motor grinds through chunks of material
- Locking straps keep material dry
- Variable speed controller minimizes material usage

SPECS:

Capacity: 882 lbs.
Materials: salt, calcium chloride and sand
Construction: Polyethylene hopper
Spread Width: 1.09 - 9.84 yds.
Warranty: 1 year

Part #s
38000 (Mate)
38200 (Mate 3-point hitch)

MEYER OFF-ROAD VEHICLE PRODUCT GUIDE | 2015



Distributed by:



Meyer Products LLC

18513 Euclid Ave.

Cleveland, Ohio 44112

Phone: 216-486-1313

Fax: 216-486-1321

Meyer Snow Plows are protected by one or more of the following patents: 8006413, D0507999 S, D05179635, 8453358, 8695238, 7,918,042 B2, CA 2,677,509 C, D0517963 S, EP 1,989,402 B1, ES 2,346,587, 6138388, 7,591,087 B2, 7,661,211 B2, 7,793,440 B1, 8739437, 8793906, CA 2,604,085C, 6354024, 6276075, 6,318,975 B1, 6564479, 6256909, 6594923, 6618964, 7114270, 7117617, 7290359, D399326 S, CA 2,300,012 C, CA 2,314,772 C, CA 2,331,653 C, CA 2,370,925 C, CA 2,455,637 C, CA 2,653,801 C, CA 2,654,856, EP 1,010,809, 7353628, 6153975, 6273729, CA 2,260,509 C, CA 2,282,045 C, CA 2,293,858 C, CA 2,298,243 C, 6265829, 6015219, 6005300, 6163985.

Meyer Spreaders are protected by one or more of the following patents: 6698997, CA 2,415,540 C, 7588195, 8448882, 8505837, 8523086, 8657208, 6186731, 6,793,154 B2, 6722590, 6715703, 6978952, 6932287, 8505838, 8827002, 5842649, CA 2,435,106 C, 6364598.

www.meyerproducts.com

Meyer Products LLC reserves the right, under its continuing product improvement program, to change construction or design details, specifications and prices without notice or without incurring any obligation.